



LS475W / LS475W+
User Manual

Table of Contents

Table of Contents.....	1
Product Features	2
Safety Precautions.....	5
Package Contents.....	6
Optional Accessories	7
Camera Controls.....	8
Getting Started.....	13
Installing Your Camera.....	16
Basic Camera Operation	18
Camera Modes	19
Camera Settings	21
System Settings.....	25
Transferring Files	28
Firmware Update.....	29
LS475W Specifications.....	30
LS475W+ Specifications	30

Product Features



New SONY STARVIS Sensor- ISO Sensitivity up to ISO 12800

Features a new SONY STARVIS CMOS sensor with improved sensitivity not only under normal lighting but also in low light and near infrared light condition.



Integrated 10 Hz GPS Processor

Integrated is the fastest 10 Hz GPS processor, that updates GPS data 10 times per second, recording your speed and location accurately. Date and Time automatically synchronizes with the atomic clock.



Advanced WDR Technology - Stunning Videos in Any Light

WDR technology, well-balanced exposure for any condition. It makes night shots brighter and prevents overexposure to create the clearest image.



Speed Camera Alert

Remind you of approaching fixed speed camera locations and mobile speed camera “hot-spots” well in advance so you can slow down in time. Stay away from traps and always stay in control.

*Currently supported: US, CA, UK, NO, PL, NL, BE, AU.

*Speed Camera Alert act as a reference and is for reference only, which does not act as an active radar detector. Please follow all traffic rules and drive safely.



Parking Surveillance

Ensure your peace of mind by recording continually even when you have parked and left your car. Record and lock a file if unusual shock or motion is detected.

**DOD DP4 hardwiring kit required*



Support to 128GB Micro SDXC Memory Card

4X storage compatibility compared to predecessor models, supports up to 128GB with more than 18 hours of recording.



DOD GPS Player

The DOD GPS Player generates 1080p video recordings with real-time driving data such as speed and location clearly at a glance.



145° Wide Angle of View

Wide angle, wide view, without distortion. The brand-new-designed optical lens captures images with ultra wide fields of view, covering up to 145 degrees, without pincushion or distortion.



f/1.6 Large Aperture Glass Lens - Super Low-Light Performance

Equipped with f/1.6 large aperture, capturing better night shots than conventional f/2.0, and records clearly sophisticated details such as the license plate and others.



6G Sharp Glass Lens

6-Element sharp lens, made of 6 layers of glass, provides stunning clear and non-deformed images.



G-Sensor Automatic Trigger for File Protection

When an impact or emergency brake occurs, the device will lock the current video files automatically. Important files will not be overwritten by loop recording.



Loop Recording

When the storage space is full, it can automatically overwrite the unprotected files.



Path Analysis

Calculate the distance, time and average speed of your journey from location A to B. It's a very economical and practical way to save your time and fuel consumption.



Circular Polarizing Filter

Adjustable CPL filter suppress glare from windshield and manage reflection. Provides clear images with enhanced contrasts.

Safety Precautions

Product

- Do not disassemble, repair, modify your camera or power related accessories. For warranty service, please contact DOD Tech Support.
- Do not adjust or operate camera while driving.
- Avoid exposing your camera to extended periods of humidity and/or heat.
- Prolonged exposure may reduce the product's lifespan.
- Do not spray water or cleaning agents directly onto the camera.
- Fluids may cause fire, electric shocks, or malfunctions.
- Avoid installing camera where it may obstruct the driver's view or airbag deployment.

Car Power Adaptor

- Use ONLY the DOD power adapter supplied with your unit.
- Other power adapters may create a safety hazard or damage the unit.
- Do not use damaged power adapters or cords. If damaged, please disconnect the power adapter and contact DOD Tech Support for assistance.
- Do not pull, insert, or bend the power cable using excessive force.
- Do not operate or handle the power cable with wet hands.
- In specified cars, the power may be constantly supplied to the device even the engine is turned off. This may drain the vehicle battery. The optional DOD DP4 kit equipped with low-voltage protection and is designed to prevent battery drain and reserve the minimum voltage required for cranking.

Battery

- Keep the device away from heaters or other hot objects.
- Store the camera at lower temperatures to reduce the rate of self-discharge and preserves the initial energy stored in the battery. The battery in the device self-discharges naturally over time whether the battery is used or not.
- Charge the dash camera for 5 minutes with the supplied DOD power cord if you are unable to turn on the camera.

Package Contents

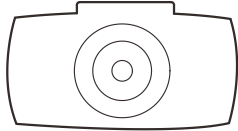

Dash Cam

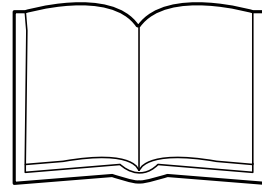

User Guide



Bracket

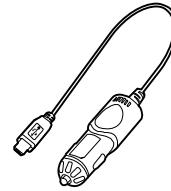

Car Power Adaptor

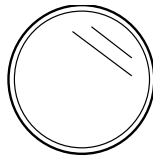

CPL
[LS475W+]

Note: Supplied accessories may vary by region.

Optional Accessories

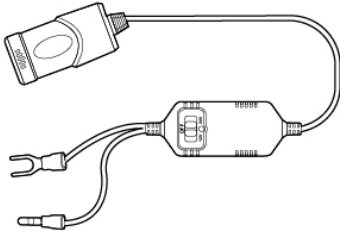

DP4

DP4 hardwiring kit offers constant source and prevent battery drain with low-voltage protection.

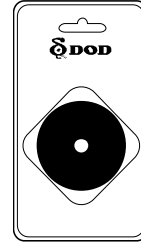

DA2S

DA2S Suction Savior provides a long lasting adhesion to suction cups.

Camera Controls

LS475W

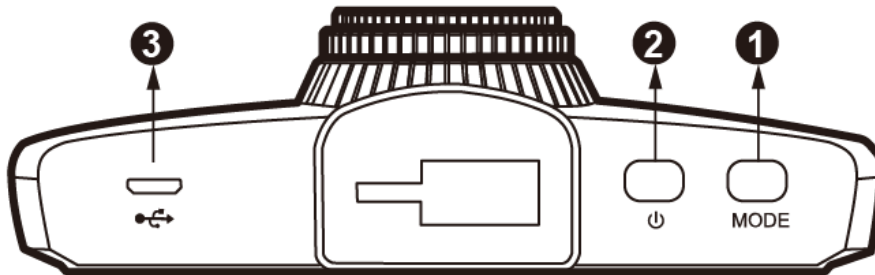

LS475W+

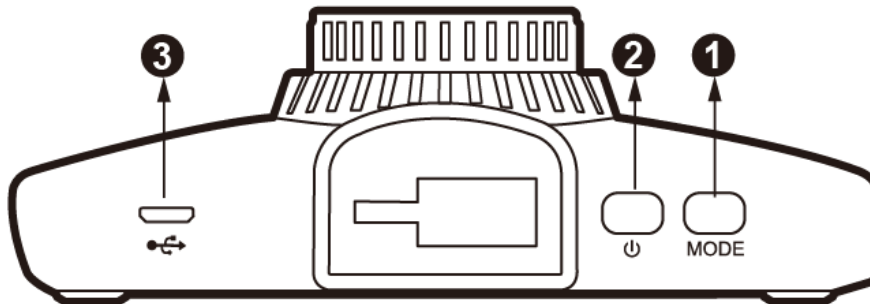

❶ Mode [MODE]

When in stand by (not recording): Press to switch between recording and playback mode.

❷ Power Button ON/OFF [⏻]

Turns unit on/off

❸ Micro USB Port [•⇄]

For use with the supplied DOD Car Power Adaptor or USB data cable.

Camera Controls

LS475W

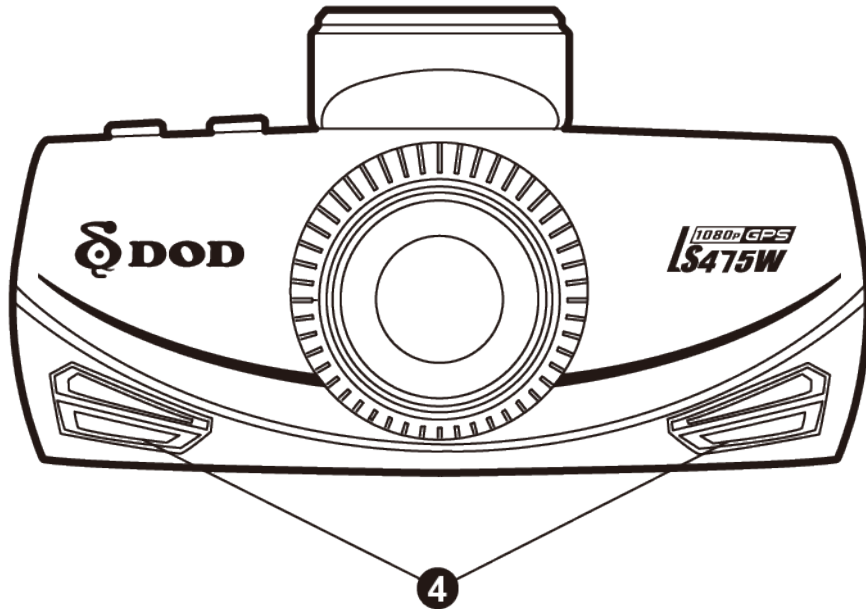

LS475W+

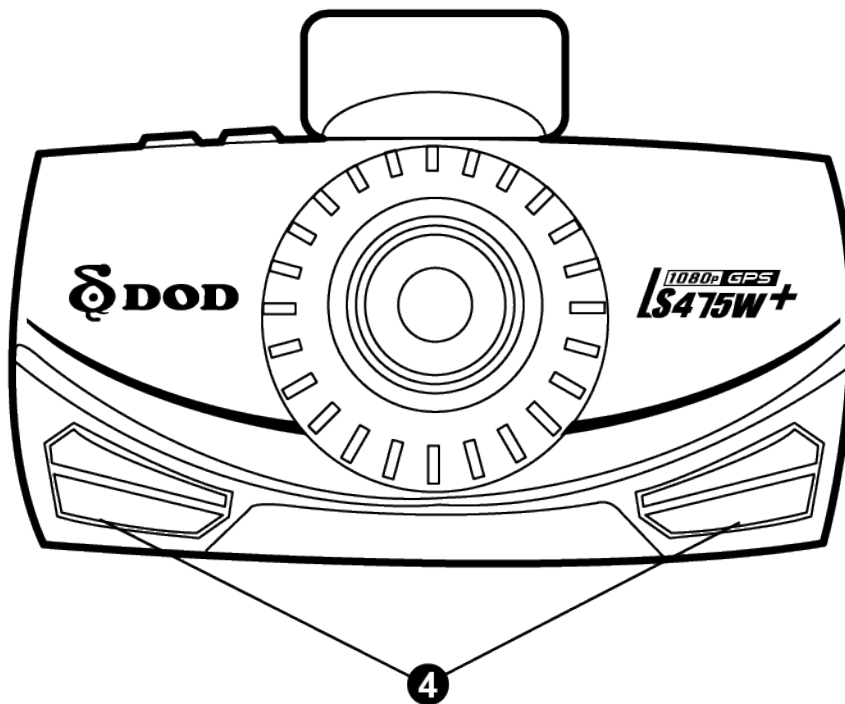

④ Speaker

Camera Controls

LS475W

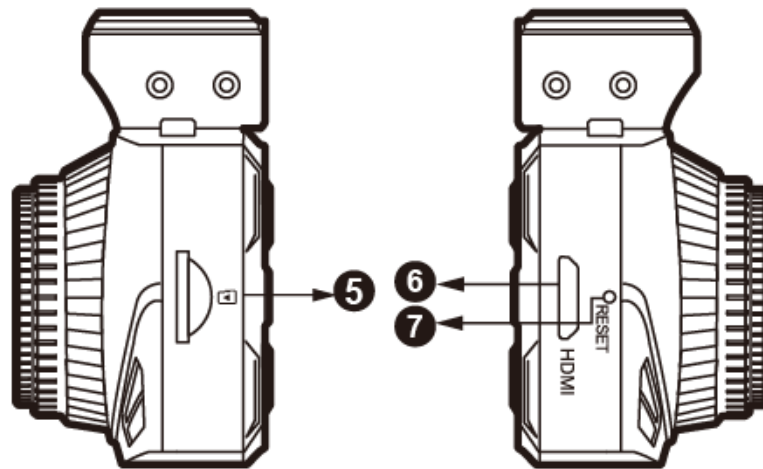

LS475W+

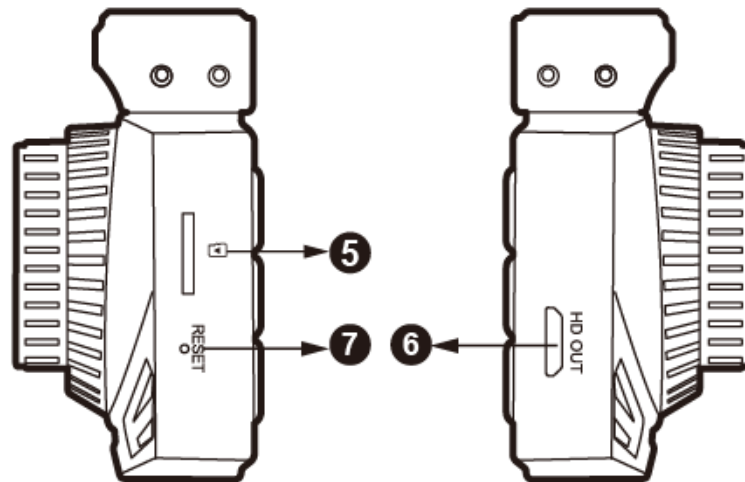

⑥ Micro SD Slot

Requires a micro SDHC/SDXC card, class 10 or above. Supports up to 128GB.

⑦ HDMI Output Slot

Outputs live view or recorded files to external display.

*Recording function is disabled while HDMI output is connected.

⑧ Reset Button

Use a small pin to press the button to force the device to reboot.

Camera Controls

LS475W

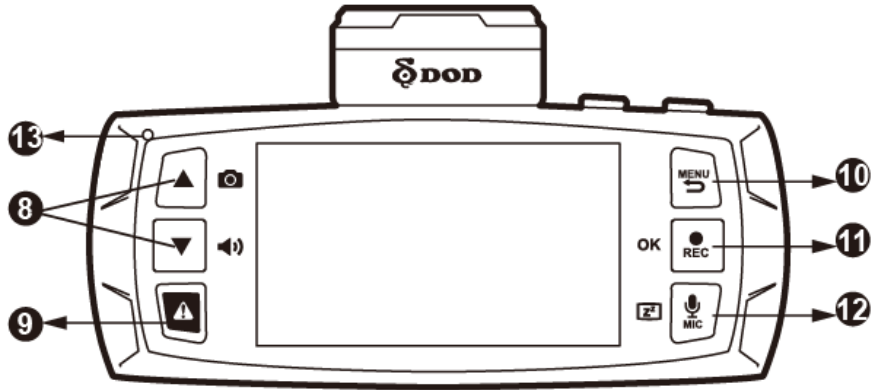

LS475W+

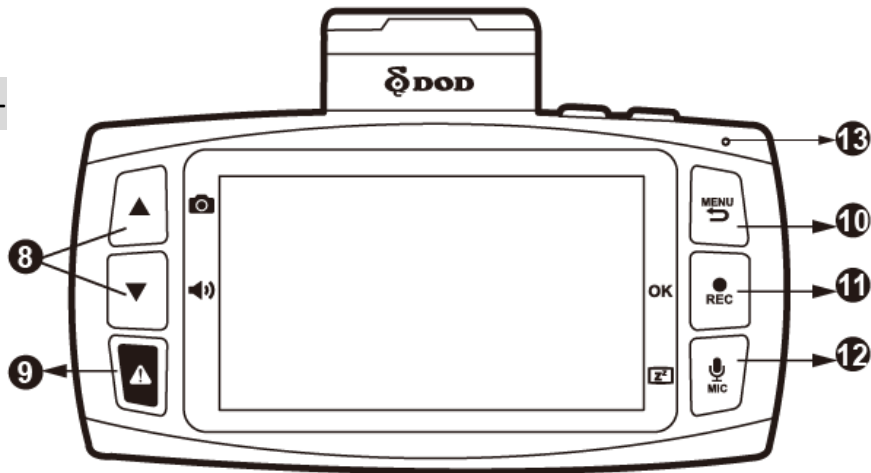

⑨ Arrow Keys [▲/▼]

Standby Mode: Used to navigate through menus and select videos for playback.

Recording Mode:

Press [▲] to capture snap shot of current recording.

Press [▼] to change notification/alert volume.

⑩ SOS Emergency File Lock [🔒]

- While recording, press this button to lock the current recording file and protect it from being over written.
- A lock icon [🔒] will appear at the bottom left corner to indicate whether the current recording is protected.

Camera Controls

11 Menu / Return []

When not recording, press to access menus, or to exit sub menu.

Press [] once for recording options.

Press [] twice for system options.

* Recording must be stopped before accessing menus.

12 OK / REC [/]

Stop or start recording.

Act as the OK button in menu.

13 MIC / Display OFF [/]

During standby / recording mode:

Press [] to **switch** ON/OFF voice recording.

Press [] and hold to turn ON/OFF LCD display. Display status does not affect continuous recording.

14 Operation Status LED

Steady blue - Unit is powered off and is charging.

Steady pink - Unit is powered on and charging but not recording.

Steady red - Unit is powered on but not charging nor recording.

Flashing red - Unit is recording and battery is full.

Flashing between blue and pink - Unit is recording and charging.

Flashing blue – Charging malfunction.

Getting Started

Setting Up Your Camera

Set up your Dash Cam inside your vehicle to ensure easy access to power.

1. Start With SD Card.

To use with SD card, please format the microSD card in the camera menu to ensure correct format before initial use. Memory card must be in FAT32 format to function properly.

Card slot is directional and may be damaged if SD card is inserted incorrectly.

To save recorded videos stably, DOD Tech recommends formatting your SD card every two weeks from in the camera

Note: After formatting the SD card, all of your data will be deleted. Be sure that you have backed up the important files.



Storage/Quality	Recording length
16GB	110 minutes (1.8 hours)
32GB	200 minutes (3.2 hours)
64GB	380 minutes (6.3 hours)
128GB	780 minutes (12.8 hours)

**Video recording length may vary depending on environmental conditions.*

Estimated Video Recording Length (1080p Full HD form)

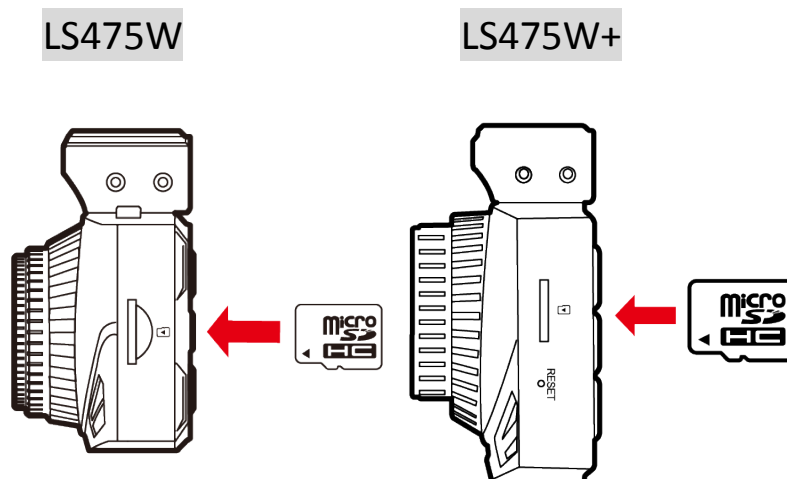

Getting Started

2. Connect the Power Adapter.

Plug the DOD power adapter into your vehicle's power/accessory outlet. Then carefully insert the micro USB plug into the USB port.

LS475W

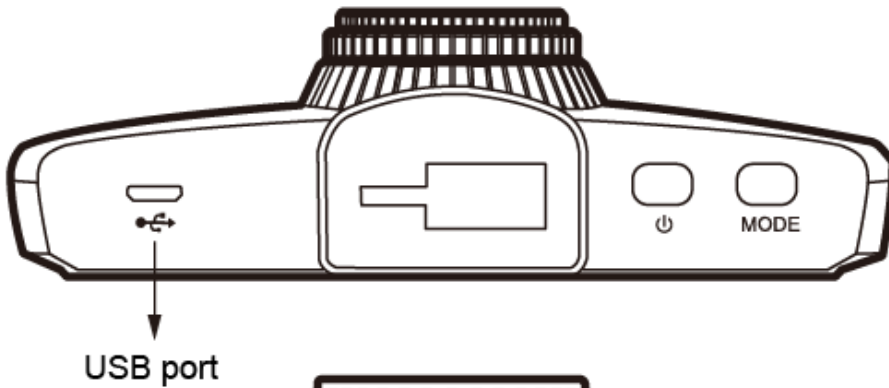

LS475W+

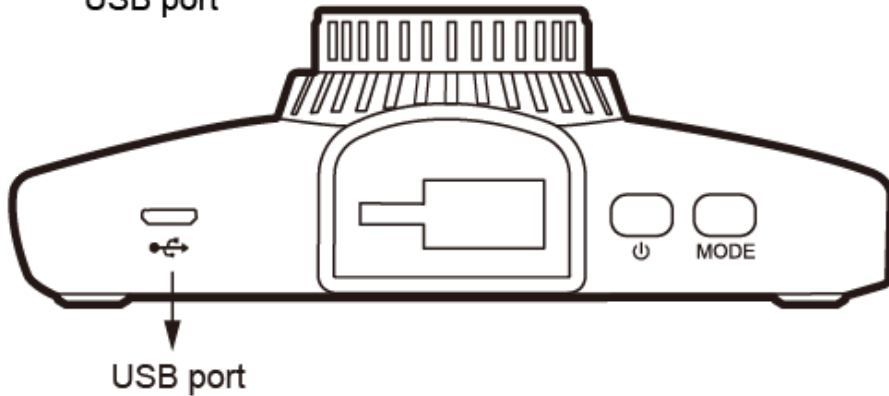

3. Turn on Your Vehicle.

Powering from your vehicle through the accessory socket will automatically turn on your camera and starts recording, and your camera will stop recording and shuts off automatically when power is turned off.



Note: In specified cars, the power may be constantly supplied to the device even when the engine is turned off. This may drain the vehicle battery. The optional DOD DP4 kit equipped with low-voltage protection and is designed to prevent battery drainage.

Getting Started

4. Turn on/off Your Camera Manually.



Press 【】 to turn on or turn off the unit manually.

*The Dash Cam will turn on and off automatically with the power supply from your vehicle.

5. Select Language→Set the Time Zone→Select the Speed Unit of Your Choice

Upon powering up the camera for the first time or after upgrading the firmware on the device, you will need to go through and input the Settings below.

Select Language

- Select the language of your choice by pressing 【▲/▼】.
- Press 【】 to proceed.
- Set the time zone
- Scroll down and select your respective time zone.
- Press 【】 to confirm.
- Your camera will automatically sync with the time and date to the atomic clock base on the chosen time zone.

Note: Daylight saving time requires adjustment manually.

- Select the speed unit of your choice – KPH or MPH



Installing Your Camera

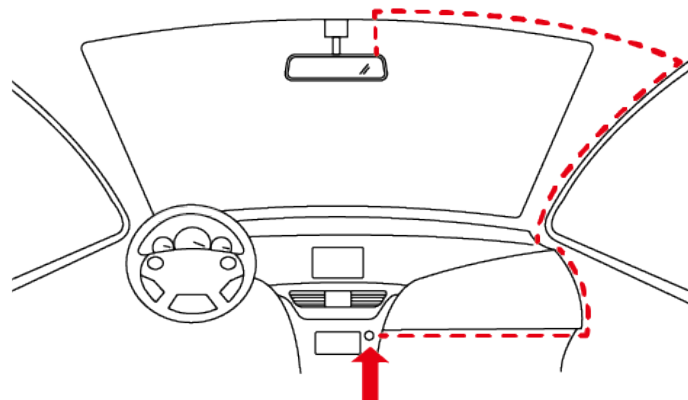
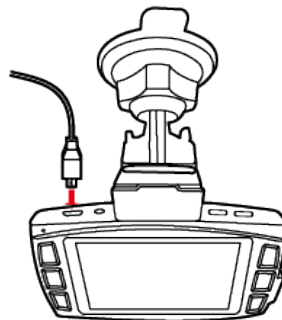
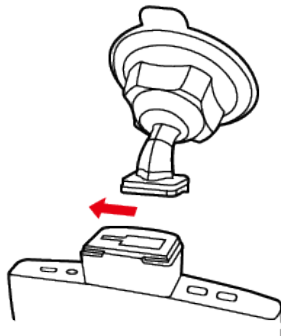
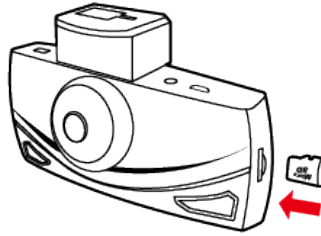

12/24V DC

Installing Your Camera

1. Clean Windshield

- Wipe down both the interior and exterior glass for the best image quality.

2. Attach the Mount to Your Camera

- Attach the camera securely to the mount
- Please insert MicroSD card to the unit.

3. Prepare the Camera for Installation

- Peel off the protective mount cover.
- Find a location which does not obstruct your view when driving.
- It is recommended to place the camera behind the rearview mirror without blocking either lenses or camera functions.

4. Adjust the Angle

- The mount has an adjustable ball joint that can be loosened using the plastic locking nut.
- Angle your camera slightly below the horizon line to minimize glare.
- Press the mount firmly against the glass and turn the mount nut clockwise to secure the mount.



5. Install the Car Power Adaptor

- If you have not done so previously, carefully insert the micro USB plug into the port on the camera, and insert the power adaptor into the cigarette lighter socket of your car.
- The wiring can be hidden in the headliner, seams and rubber strips around the perimeter of the windshield.

6. Remove the Lens Protector Film

Your camera is now installed and ready for daily use.



Note:

- Always use the supplied DOD car power adaptor to avoid the unexpected damage.
- If grease, fingerprints, or blots are found on the external/internal windshield of the car, please wipe it clean or replace the windshield. Blots may affect the recording quality or may cause the bracket to be unstable.
- Due to various road condition in different countries, DOD Tech recommends setting the G-Sensor sensitivity accordingly to suit driving environments in your country.

Basic Camera Operation

Everyday Operation

Dash cam will automatically turn on and start recording when it starts receiving power. By default, the camera will record over the oldest videos when the memory card is full (loop recording). The protect files can take up to 30% of full SD card space, and not be overwritten by normal recording files. When reaching 30% limit, files in RO (Read Only) folder will be overwritten by newest protected file, starting with the oldest.

Continuously Powered Electrical Outlet

The camera will not automatically shut down when your vehicle is turned off. If your vehicle provides continuous power to the accessory outlet. To turn off your camera manually, simply unplug the USB cable or press the power button or power button.



Continuously powered electrical outlet allows the camera to capture videos while you are away but it will result in vehicle battery drainage and may eventually prevent your car from starting. DOD Tech recommend to use DP4 power kit for needs of parking surveillance.

Manually Turning On/Off Your Camera

- Press **【⏻】** to turn on/off your camera.
- Press **【[●]REC】** to begin/stop recording.

Video Directory:

Videos will be saved on the memory card and or in internal storage. Normal driving videos are in the root directory and the protected files will be saved in the “RO” (Read Only) file.

File-naming for camera: 2017_0125_180946_001

- Blue number sequence in example above indicates year/month/day,
- Green number sequence indicates time in 24H format including seconds,

Camera Modes

- Standby Mode: Press 【MODE】 to switch in between Video Recording and Playback Mode.
- Press 【REC/OK】 to stop recording before pressing 【MODE】 to switch modes.

1. Recording Mode



Note: GPS icon flashes when it searches for GPS signal. HUD, Over-Speed Warning and Speed Camera alerts only work when the GPS signals is stable.

●	Recording Status	Flashes when recording.
EV	Exposure Value	Indicates the current exposure value setting.
MIC	MIC	Indicates if the audio recording is on or off.
Battery	Power Status	Indicates the power source and the battery status if external power is not connected.
ISO	ISO Sensitivity	Indicates the current ISO value.
Lock	SOS File Lock	Indicates current recording file is locked and protected. This can be triggered by G-sensor or by pressing the SOS file lock button,
Memory Card	Memory Card Status	Indicates if a memory card is inserted.
GPS	GPS Status	Flashes whilst the device is searching for satellites. Once the positioning is done, the icon will be solidly displayed.
Date/Time	Date/Time	Current date and time.

Camera Modes

2. Playback Mode

You can watch previously recorded videos in Playback Mode.

Press [MODE] to switch into the Playback Mode when unit is not recording.

● Play the Video

- Press [▲/▼] to choose file.
- Press [REC] to play or pause.
- While playing video, press [▲/▼] to forwards/backwards.
- Press [MODE] to exit the Playback Mode.

● Delete or Protect Files from the SD card.

- Press [▲/▼] to choose file.
- Press [MENU] to enter Playback Menu.
- Press [▲/▼] to select delete or protect current file.
- Press [REC] to confirm.
- Press [MENU] to exit.

Note:

If protected, a lock icon will appear on the screen.

If deleted, it cannot be undone. Choose “delete all” will not erase protected files.

The “Format” function will erase all files including locked files.

● Slideshow

- Press the menu button and navigate to slideshow.
- Photos and the first frame of each video will be shown in order.



Camera Settings

Each mode has a unique set of settings. See the description below.

Two Camera Settings menus are accessible:

- Functional Settings
- System Settings

The menu settings can be switched by pressing **【^{MENU} ⏏】**.

If you move the cursor before pressing **【^{MENU} ⏏】** to access to system menu, exit and try again.

*Note: Press **【^{REC} ●】** to stop recording before entering the camera menus.*

Video Recording: Functional Settings Page

Accessed by pressing **【^{MENU} ⏏】** once.

● Resolution

Default with camera in 1080p Full HD at 60fps.

● Loop Recording

Can be set to 1,3,5 or 10 minutes. Video recordings of the selected length will be recorded onto the memory card. When the memory card is full, the oldest files will be overwritten, excluding locked clips. Turning off loop recording will result in 30min per video and will prevent the camera from writing new files when the memory card is filled.

● Exposure Value

Sets the brightness /darkness of the video.

Video too bright? Set between -1 to -3.

Video too dark? +1 to +3.

Recommended setting: 0

● Record Audio

Switches the microphone recording on/off.

Options can be changed during recording by pressing button **【^{MIC} 🎤】**.

● Date Stamp

Imprints the time and date in the recorded video.

Camera Settings

● G-Sensor

Measures G-forces. The sensitivity settings can be set off/low/mid/high, If excessive force is detected, the current recording video will be locked and the file will be saved in the “RO” directory. However, *Setting G-Sensor to OFF may result in faulty function in Parking Surveillance Mode.*

Recommended setting: low. Inappropriate setting per environment or road condition will result in frequently file lock.

● Image Rotation

Rotates the recorded image 180° when Dash Cam is mounted upside down.

● Parking Surveillance (Default: Off)

When function is enabled, the Dash Cam will automatically switch to Parking Surveillance Mode if vehicle is stationary for over 10 minutes.

1. Automatically records videos when motion is detected within view range of camera.
2. Automatically records and locks recording videos when excessive force of impact is detected by G-sensor.
3. Camera only records when motion or impact is detected.
4. Unit will return to normal recording mode if vehicle moves continuously for 3 seconds or longer.

Note:

Parking Surveillance requires consistent power supply via vehicle battery. (It is recommended to use optional DOD DP4 kit equipped with low-voltage protection design to prevent battery drainage.



Please ensure to enable G-sensor function in setting menu before switch to Parking Surveillance. (G-sensor sensitivity Default: Medium)

Parking Surveillance will automatically shut down GPS locating, and will resume when switched to normal recording mode.

Enabling Parking Surveillance will automatically shut down Time-Lapse function if previously turned on.

Back lighting will automatically dim when entering Parking Surveillance, and will resume when exit.

Camera Settings

ISO Stamp

Imprints ISO value (light sensitivity value) on the video file.

On/Off

Default: On.

Set Time Zone

Sets the current time zone for GPS time and date auto calibration. Note the time zone must be manually adjusted for daylight savings

Speed Units

Select metric or imperial units.

Path Analysis

Calculates the total distance, travel time, and average speed of your journey from the beginning of your trip to the end (when camera is turned on to when turned off). If Path Analysis is set to “on”, the results will be displayed on the screen when the unit is turned off. Normal recording will resume If power is reconnected during display.

Default: Off.

Driver Fatigue Warning

Sets a timed delay before showing a visible alert reminding the driver to take a break.

Default: Off.

GPS Logging

On/Off.

Default: On

Head Up Display

Screen will show current speed and direction. If enabled, the set speed warning will also appear on display.

Default: Off.

Speed Warning

Shows a visual warning on the head-up display when the set speed has been exceeded.

Default: Off.

Camera Settings

Speed Stamp

Imprinting speed in video footages. This can be turned on/off.

Time-Lapse

The time-lapse function is used to create a sped-up video. When set, the camera will record one frame every 200ms (milliseconds)/500ms/1 second/5 seconds.

Default: Off.



Note: Time-Lapse cannot work with Parking Surveillance, this function will automatically turn off when Parking Surveillance is enabled.

Plate Stamp

Imprints a customized set of 8 digits to the recorded video. Add license plates, driver name or other identifying words to watermark your video.

Password Settings

Set a password lock which will prevent files from being deleted or prevent the menu from being accessed.

Note: This does not prevent other users from extracting the memory card or changing the files via computer.

Traffic Camera Warning

Warning sound and on-screen icon to remind you of approaching traffic camera such as fixed speed camera, red-light camera or hot-spots for mobile police camera. Traffic camera warning will not be activated below 20km/h or 12mph. Speed camera icon will not appear in Heads Up Display mode.

Note: Currently supported: US, CA, UK, NO, PL, NL, BE, AU.

****Please make sure "Volume" is turned on in setting menu**

***Traffic Camera Alert act as a reference and is for reference only, which does not act as an active radar detector. Please follow all traffic rules and drive safely.**

System Settings

Accessed by pressing **【MODE】** twice while standby.

- **Date/Time**

When GPS signal is not available, manually sets year/date/time as well as display format.

- **Volume**

Turns on/off all sounds, including button and notification.

- **Language**

- **Screen Saver**

Set 3/5/10min before display turns off to reduce driver distraction. Dash Cam still records when screen saver is activated. Screen saver does not activate in Parking Surveillance mode.

- **Display Brightness**

Adjust screen back lighting.

- **Flicker Reduction**

Adjusts the camera's frequency setting to minimize flickering and banding in the recorded video. Flick reduction: 50Hz/60Hz is related to the light frequency in your location. Normally the frequency is correlated to local voltage rating, if you find the video recorded at night is glimmering, please adjust light frequency per your location.

- **Format Memory Card**

Completely deletes all files including locked footage from the SD card and optimizes the card for recording. DOD Tech suggest formatting via the menu every two weeks to ensure proper SD card functionality.

- **Factory Reset**

Reverts all settings back to the original factory default.

- **Firmware Version**

Shows the model name and current firmware version.

Play on DOD Player

Please transfer the video files to your electronic device for smooth viewing and or storage. The DOD Video Player is a user-friendly program to playback videos and to visualize your position and speed on your PC or Mac.

Installing the DOD Video Player

Download the software from DOD Tech's website and follow instructions for installation.



Suggested System Requirements:

Windows XP or higher (i3 or better, with at least 2GB Ram)

Mac OSX 10.6.4 or higher

Launching the DOD Video Player

Once launched, the player will appear on your screen.



Click the Player icon below to view instruction video



goo.gl/IUM9qd

Please ensure internet access before viewing instruction video

Learn more about DOD GPS PLAYER V2.0

Play on DOD Player

Open Video Files

Add your file to the list of videos:

- Click “File”, click “Open”, and navigate to the location of your files.
- Press the “ADD” button located below the list of videos.

Video Player Features

- Once the video is playing, your position, speed and G-Force will be displayed at the bottom of the player window.
- Pressing the “Location Map” button will show your position on Google Maps.

Transferring Files

Video files can be transferred to your electronic device for viewing and storage.

USB Cable

1. Connect a USB cable from the camera's USB port to computer.
2. Camera will automatically turn on and should show "Mass Storage" on display.
3. Computer should now detect the camera as a flash drive in directory.

Card Reader/MicroSD Slot

Use a Micro SD card adaptor (purchase separately) or a compatible electronic device with a MicroSD slot (ex: tablet). Follow the manufacturer's instructions.

Video Output

HDMI (TV)

Connecting a mini-HDMI to HDMI from your camera to a compatible television/monitor will automatically output the camera's screen. Recording functions are disabled while streaming video.

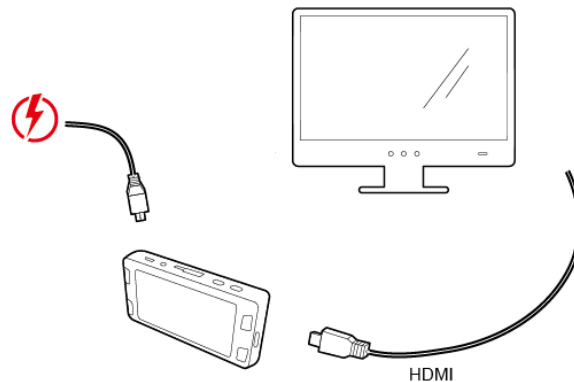

Firmware Update

See the support section on DOD Tech's website for any available firmware updates and instructions.



Note:

- *Please ensure stable power during firmware update, otherwise may result in update failure or malfunction.*
- *When update completes, system will show option to format SD card. Please ensure to format SD card by computer / dashcam to prevent update repeatedly.*

About SD Card

- Test the Micro SD memory card regularly as the memory card is a consumable item, and needs to be replaced periodically.
- Reformat the memory card in the camera menu every two weeks to extend usable lifetime. This should only be done AFTER desired files have been saved elsewhere, such as portable hard drive. Formatting the memory card will clear all files, including RO files.
- DOD is NOT responsible for any malfunctions caused from the use of disingenuous, modified, or unauthorized parts and accessories.
- DOD does NOT guarantee the recording of accidents which may produce excessive force of impact causing the device to malfunction and fault.
- The working temperature of this product is -20°C~65°C(-4°F~149°F). Please ensure the device is stored within the temperature range; or the device may be damaged and or malfunction, which these circumstances are not covered by warranty.
- DOD is NOT responsible for the loss of any recorded video during operation due to unexpected factors or force majeure when driving.
- The video recordings filmed by this Dash Cam are intended for personal use ONLY.
- Suggested to use Class 10 and MLC flash memory cards.
- DOD Tech recommend **NOT** to use Sandisk branded or TLC flash memory cards.



Note:

- *64GB or greater capacity cards will show "SD Card Error" when first insert into dash cam. Please use formatting function in system menu to format SD card prior to usage to ensure proper functionalities.*
- *When formatting via computer, 64GB or greater requires formation program to transform original exFAT format to FAT32 to properly function in dash cam.*

LS475W Specifications

Video Resolution	1920x1080@60fps
Sensor	SONY STARVIS CMOS sensor
Wide-Angle Lens	145°
Aperture	f/1.6
ISO Sensitivity	up to ISO 12800
Display	2.7" 16:9 TFT LCD
Video Format	H.264 MOV
Recording Media	micro SDHC/SDXC Card (Up to 128GB)
Audio	Mic and Speaker(Mono)Equipped
Battery	3.7V 180mAh Lithium Battery
Power Input	5V 1.5A
Size	112.6 (L) x 61.5(W) x 33.4 (H)mm
Weight	110g
Operating Temperature	-20°C ~65°C

LS475W+ Specifications

Video Resolution	1920x1080@60fps
Sensor	SONY STARVIS CMOS sensor
Wide-Angle Lens	145°
Aperture	f/1.6
ISO Sensitivity	up to ISO 12800
Display	3" 16:9 TFT LCD
Video Format	H.264 MOV
Recording Media	micro SDHC/SDXC Card (Up to 128GB)
Audio	Mic and Speaker(Mono)Equipped
Battery	3.7V 900mAh Lithium Battery
Power Input	5V 1.5A
Size	112 (L) x 71.9(W) x 36.4 (H)mm
Weight	145g
Operating Temperature	-20°C ~65°C

All Specifications Are Subject to Change without Notice.

Copyright ©2017 DOD Tech

All Rights Reserved

Under the copyright laws, this manual may not be copied,
in any way, shape, or form, without the written consent of DOD Tech.